





**IRON DOG<sup>®</sup>**  
**EISERNER HUND<sup>®</sup>**

ein hund ist treu, liebt die nähe zum menschen und freut sich,  
wenn jemand nach hause kommt. eisern, weil er hart ist und  
natürlich weil er aus gusseisen besteht.

der »eiserne hund« hält ein leben lang. er ist ein holzofen der  
besonderen art. finde deinen typ. jeder ist anders und einzigartig.  
er wird dein freund.

*a dog is loyal, loves being close to people and is pleased when  
someone returns home. iron because it is hard and natural  
because it is made of cast iron.*

*the »iron dog« stays with you for life. it is a special kind of  
wood-fired stove. find your type. each of them is different and  
unique. he will be your friend.*



# EISERNE HUNDE

sind gussöfen made in germany. hergestellt von einem familienbetrieb in der 3. generation, der bis heute nur holzöfen gebaut hat. in dieser serie steckt all das können und wissen für einen außergewöhnlichen ofen in außergewöhnlicher qualität. deshalb auch der außergewöhnliche name »eiserner hund«.

für außergewöhnliche menschen oder als geschenk an freunde.

# IRON DOGS

*are cast stoves made in germany. they are manufactured by the 3rd generation of a family-owned company which has only manufactured wood-fired stoves right up to today. this production comprises all of the skills and knowledge which is required for an extraordinary stove of an extraordinary quality. this is why they also have the extraordinary name »iron dog«.*

*for extraordinary people or as a gift for friends.*



# IRON DOG®

## das lastenheft. *the specifications.*

produkt:	kaminofen
<i>product:</i>	<i>chimney stove</i>
brennstoff:	holz/kohle
<i>fuel:</i>	<i>wood/coal</i>
design:	gestaltung mit designern und künstlern
<i>design:</i>	<i>designed by designers und artists</i>
name:	aussagekräftig, einzigartig, international
<i>name:</i>	<i>meaningful, unique, international</i>
material:	gusseisen, 7 mm
<i>material:</i>	<i>cast iron, 7 mm</i>
konstruktion:	dichte verschraubung, verbindungstechnik edelstahl
<i>construction:</i>	<i>tightly screwed connections, stainless steel thread</i>
besonderheit:	gute form, einfache bedienung, geringe emission
<i>special feature:</i>	<i>good form, easy to use, low emission</i>
lebensdauer:	mind. 100 jahre
<i>serviceable live:</i>	<i>min. 100 years</i>
produktionsort:	deutschland
<i>place of production:</i>	<i>germany</i>
zielgruppe:	menschen mit anspruch auf form und qualität
<i>target group:</i>	<i>people who demand form and quality</i>

der name »eiserner hund« - »iron dog« - ist als marke eingetragen und geschützt.

*the name »eiserner hund« - »iron dog« - is registered and protected as a trademark.*

# zahlbar & preiswert. *affordable & inexpensive*

ein holzofen muss bezahlbar sein.  
die qualität spürbar.

*a wood-fired stove must be affordable.  
the quality noticeable.*

design: design.mattis, darmstadt  
giesserei: ortrander eisenhütte  
mit präzisionsmaschinen bearbeitet  
von menschenhand montiert  
26 gussteile  
3 stahlwellen  
65 edelstahlschrauben  
1 glaskeramik

*design: design.mattis, darmstadt  
foundry: ortrander eisenhütte  
manufactured using precision machines  
assembled by humans  
26 cast parts  
3 steel shafts  
65 stainless steel screws  
1 glass ceramic*

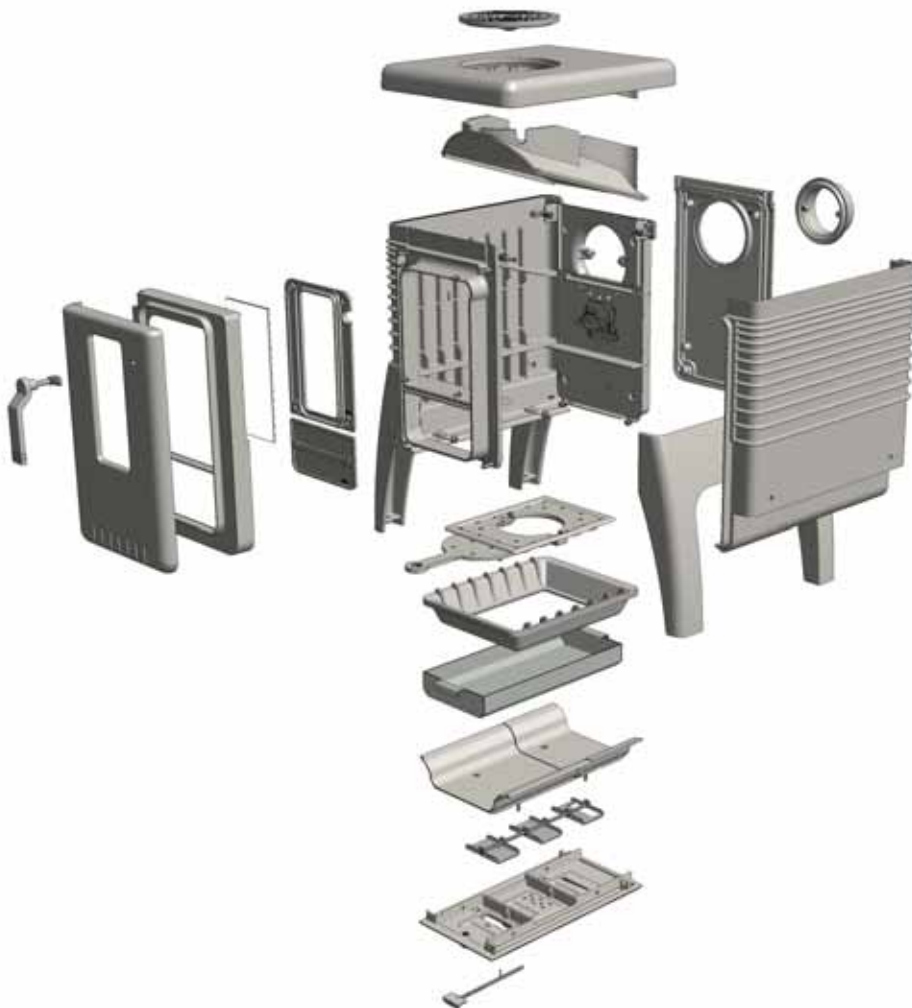





# IRON DOG<sup>®</sup> N° 01

ist alles im leben technisch  
abzusichern?

wärme ist ein grundbedürfnis.  
wer einen holzofen besitzt, kann kälte  
besiegen - mit einfachsten mitteln.

*can everything in life be secured  
by technical means?*

*warmth is a basic need.  
a person who owns a wood-fired stove  
can conquer the cold - with the simplest  
means.*

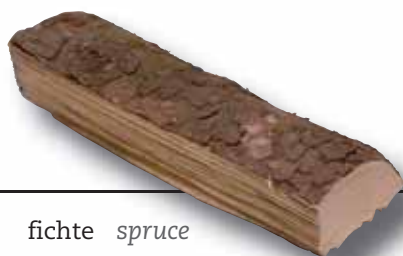
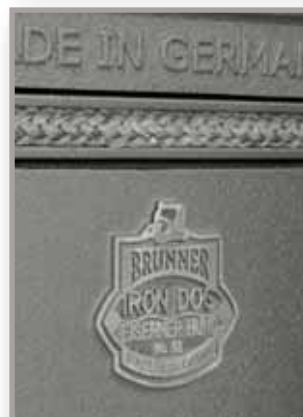

fichte spruce





# IRON DOG<sup>®</sup>

## N° 02

sind gefühle wichtig?

gefühle entscheiden alles.

über menschen, situationen oder produkte.

*are feelings important?*

*feelings decide everything.*

*about people, situations or products.*

12 | 13



ahorn maple



# IRON DOG® N° 03

kann ein holzofen ein guter  
freund sein?

vertrautheit, erinnerungen, schöne  
momente vor dem wärmenden feuer  
sind etwas besonderes.

*can a wood-fired stove be  
a good friend?*

*familiarity, memories, beautiful moments  
in front of the warming fire are some-  
thing special.*



esche ash





# IRON DOG® N° 04

können ein paar holzscheite und  
ein bequemer sessel glücklich machen?  
zeit, muse und wohlbefinden sind durch nichts zu  
ersetzen.

*can a few logs and a comfortable armchair  
make someone happy?*

*time, muse and well-being cannot be replaced by  
anything*

16 | 17



buche beech







# IRON DOG<sup>®</sup> N° 05

gusseisen.  
cast iron.

kunst und wärme -  
passt das zusammen?

nichts ist so frei wie die kunst  
und die menschen, die sie lieben.

*art and warmth -  
do they match?*

*nothing is as free as art  
and the people who love it.*

## huraxdax



gussgrau iron grey



anthrazit anthracite



eiche oak



huraxdax • aufbruch zur freude • decampent to joy • il piacere spicca il volo • la via del benessere • ИСТОЧНИК РАДОСТИ  
une explosion de joie • het zonnetje in huis • uppbrott till glädje • skaper velvære og trivsel • olkaamme iloisia  
wybuch radości • Začátek radostných chvíl • Эківа́дме Яіа Хапа́ • huraxdax



# IRON DOG<sup>®</sup> N° 05

**silber & gold**  
*silver & gold.*

wer das eisen nicht ehrt,  
ist des goldes nicht wert.

für menschen, die den holzofen als wertanlage wollen, wird dieses modell in sterlingsilber oder gold gegossen. der holzofen ist alltagstauglich und wird auftragsbezogen für ausgewählte kunden handwerklich gefertigt. nur feuertürhitzeschild, rost und umlenkung sind aus gusseisen. jedem HURAXDAX in edelmetall liegt eine expertise bei, mit dem die einzelnen teile mit ihrer teilenummer aufgeführt und mit angabe des einzelgewichts bestätigt sind.

teilgewicht	sterlingsilber	ca. 170 kg
	750er gold	ca. 260 kg

*take care of the iron  
and the gold will take care of itself.*

*this model is cast in sterling silver or gold for those who want a wood-fired stove as an investment. the wood-fired stove can be put to everyday use and is made on order for selected customers. only the fire door heat shield, the grate and the heating gas deflection are of cast iron. each HURAXDAX in precious metal is supplied with an expertise which lists each of the components with their part numbers with confirmation of the weight in each case.*

component weight	sterling silver	approx. 170 kg
	750 gold	approx. 260 kg

huraxdax



birne pear

altar der wärme.  
feuerschein und knistern.  
kann man wärme zelebrieren?  
gibt es spezielles opferholz?  
zapfen, äste und trockenes moos?

*altar of warmth  
firelight and crackling.  
can one celebrate warmth?  
does special sacrificial wood exist?  
cones, branches and dry moose.*



# IRON DOG<sup>®</sup> N° 06

lebensfreude oder  
männerspielzeug?

wärme und ein zufriedener bauch,  
was immer es sein soll.

*life's joy or man's toy?*

*warmth and a satisfied belly,  
whatever it should be.*

## kochmaschine *cooking machine*



ahorn maple





# IRON DOG<sup>®</sup> N° 01

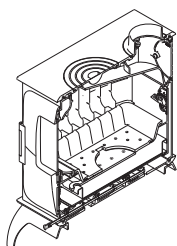
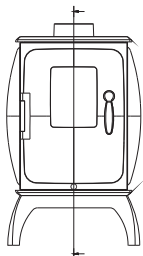
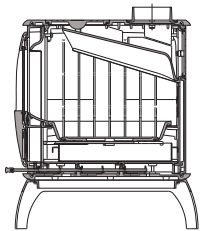
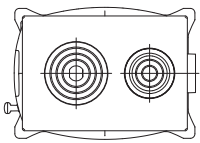
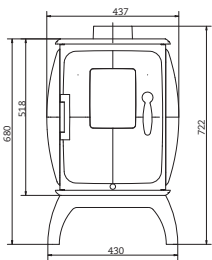
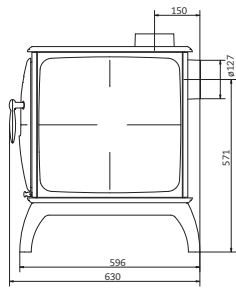

# IRON DOG<sup>®</sup> N° 02

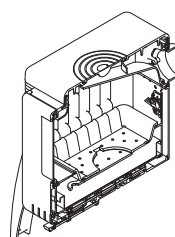
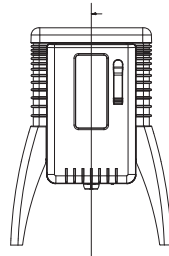
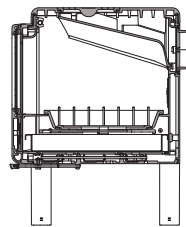
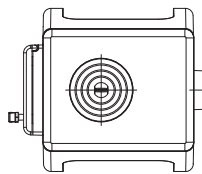
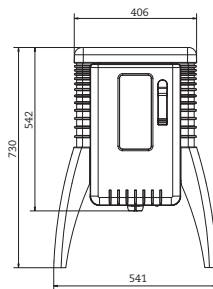
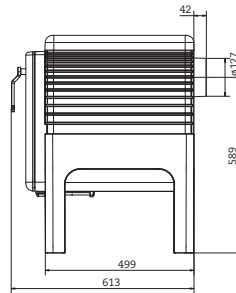

# IRON DOG<sup>®</sup> N° 03

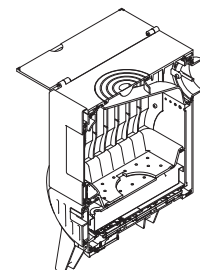
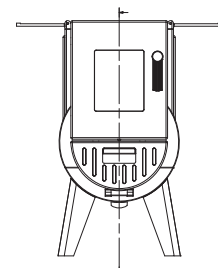
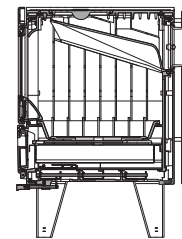
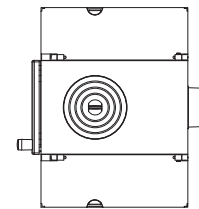
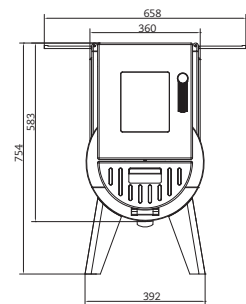
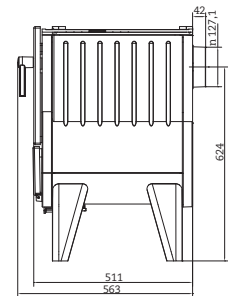



# IRON DOG<sup>®</sup> N° 04

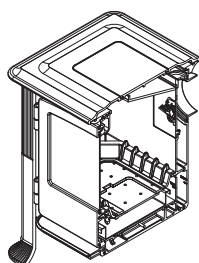
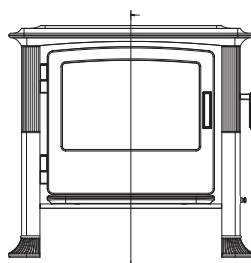
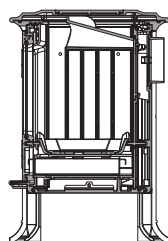
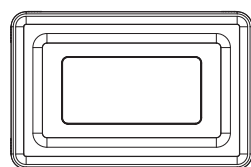
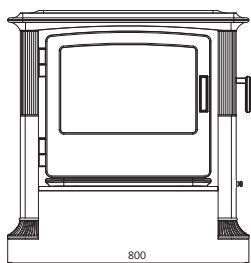
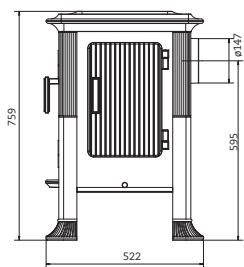

# IRON DOG<sup>®</sup> N° 05

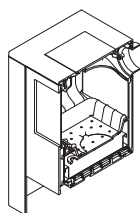
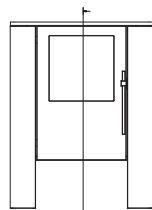
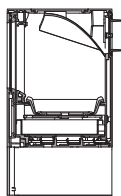
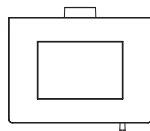
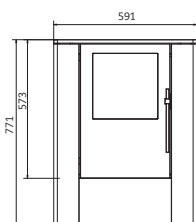
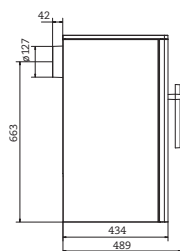

# IRON DOG<sup>®</sup> N° 06

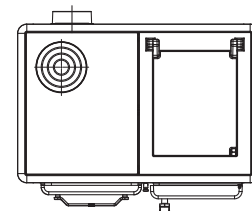
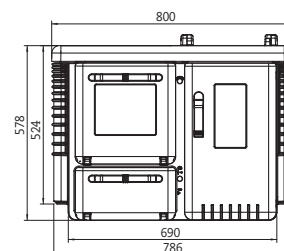
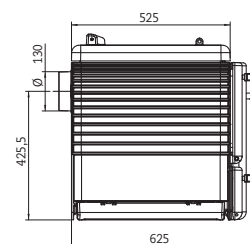
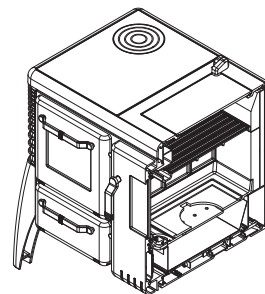
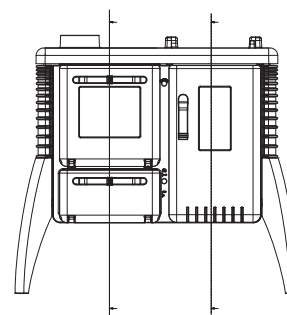
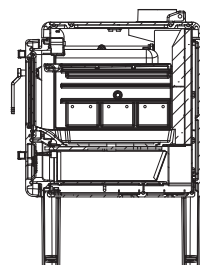
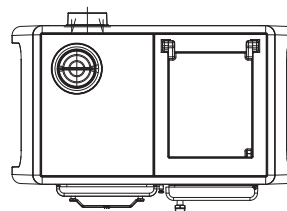
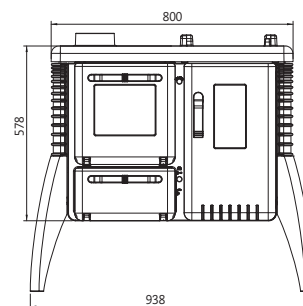
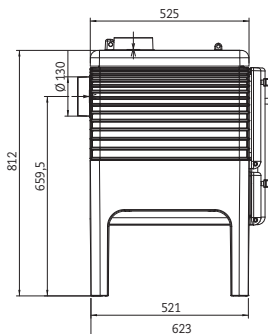

## technik. technology.

eine ausgeklügelte verbrennungsluftzuführung sorgt für eine langsame und gleichmässige entgasung der holzscheite bei geringsten emissionen bzw. verbrennungsrückständen. die primärluft ① strömt direkt in die glutwanne und treibt sanft die entgasung an. die sekundärluft ② hält die glasscheibe sauber und durchmischt die brenngase mit dem notwendigen sauerstoff vor dem flammkanal ③. mit der tertiärluft ④ werden die im hinteren bereich des feuerraumes austretenden gase zeitnah durchmischt und zur zündreaktion gebracht.

die bedienung erfolgt mit einem einzigen stellelement ⑤. einfacher kann ein holzofen nicht bedient werden.

der hohe wirkungsgrad wird durch große wärmeaufnahme-flächen in kombination mit besonderer heizgasumlenkungen erreicht.

für die befeuerung mit schwarzem brennstoff (kohle, anthrazit, torf) werden »eiserne hunde« auch in der ausführung multi-fuel angeboten. diese unterscheidet sich speziell über eine andere brennrosteinrichtung.

*a cleverly devised combustion air feed ensures a slow and constant degassing of the logs with the lowest possible emission and combustion residue respectively. the primary air ① flows direct into the embers pan and softly impels the degassing. the secondary air ② keeps the glass plate clean and thoroughly mixes the combustion gases with the required oxygen in front of the flame tube ③. the tertiary air ④ promptly mixes the gases which are emitted at the rear part of the combustion chamber and these are then ignited.*

*the operation takes place with a single adjusting element ⑤. there is no easier way to use a wood-fired stove.*

*the high degree of efficiency is achieved by means of large heat absorption surfaces in combination with special heating gas deflections.*

*for heating black fuels (coal, anthracite, peat) »iron dogs« are also available in the specification multi-fuel. these models are delivered with a special designed grate.*

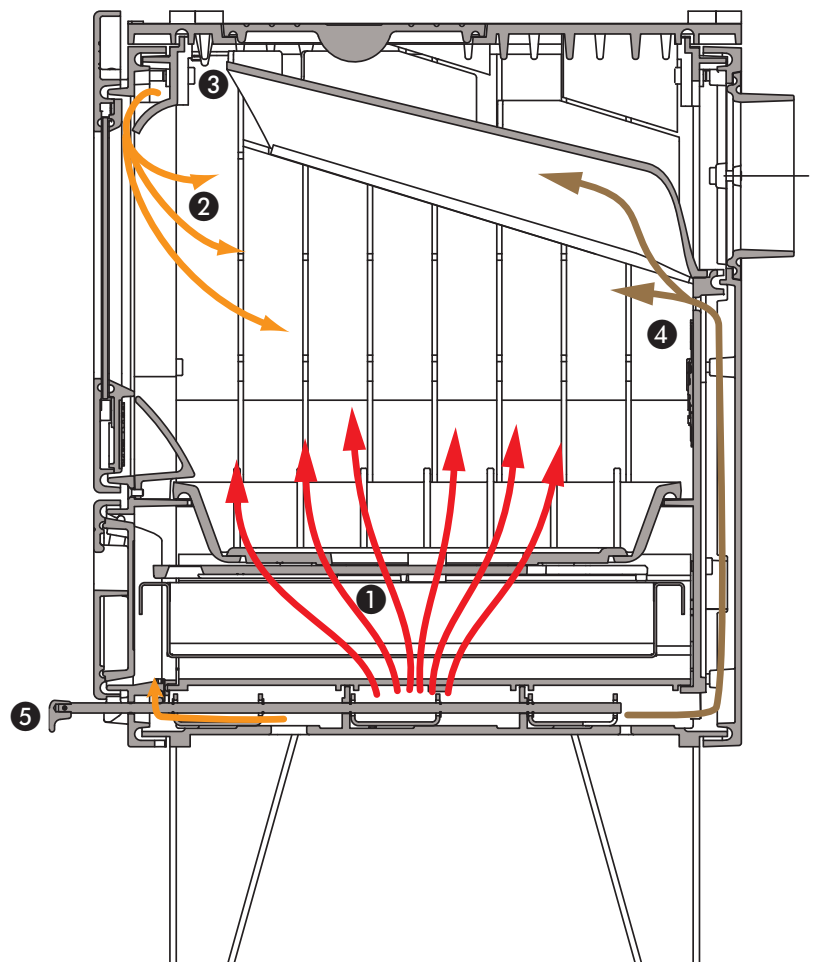



wir machen alles selbst.  
*everything is our own work.*



das klingt zwar etwas altmodisch und deutsch, hat sich aber bewährt.

nur wenn man das ganze kennt, hängt seele und stolz aller mitarbeiter an einem produkt. und das spürt man.

das beginnt mit der konstruktion mit eigenen ingenieuren und technikern, geht weiter mit einem prototyp im prüflabor und dann die serie in unserer eigenen giesserei.

montage und kontrolle sind dann die letzten handgriffe, bevor ein IRON DOG in die kiste kommt.

und gibt es einmal etwas zu verbessern, so tun wir das sofort und gerne. schließlich ist es unser produkt.

*it might sound a little old-fashioned but it is proven and tested.*

*only when everyone knows everything, does the soul and pride of all of our employees hang on a product, and one notices it.*

*it starts with the design which is carried out by our own engineers and technicians, continues with the prototype in the test laboratory, followed by our own foundry.*

*work, assembly and inspection and the last finishing touches before an IRON DOG is packed.*

*if anything should have to be improved, we do so immediately and like doing it. It is our product after all.*

ulrich brunner

# technische daten. technical data.

		iron dog 01	iron dog 02	iron dog 03	iron dog 04	iron dog 05	iron dog 06
nennheizleistung nominal heat output	kW	7	7	7	8	7	8
verbrauch/h consumption/h	kg	2	2	2	2,2	2	2,5
raumheizvermögen space heating capacity	m <sup>2</sup>	50 - 90	50 - 90	50 - 90	60 - 110	50 - 90	60 - 110
wirkungsgrad degree of efficiency	%	81	81	81	82	81	82

## gerätedaten appliance data<sup>1)</sup>

maße (h x b x t) dimensions (h x w x d)	mm	680 x 440 x 630	730 x 540 x 610	760 x 390 x 560	760 x 800 x 520	770 x 590 x 490	810 x 940 x 625
scheibenfläche (h x b) glass pane surface	mm	195 x 150	245 x 105	195 x 160	285 x 450	250 x 260	207 x 102
feuerraumöffnung (h x b) combustion chamber opening	mm	200 x 245	205 x 210	208 x 195	255 x 218	265 x 295	238 x 267
grillrostfläche hot plate	mm	---	---	---	---	---	260 x 360
bratrohr (h x b x t) baking oven	mm	---	---	---	---	---	270 x 300 x 415
rauchrohranschluß flue outlet		oben/rückwand top/back	rückwand back	rückwand back	rückwand back	rückwand back	oben/rückw. top/back
rauchrohrdurchmesser flue diameter	mm	130	130	130	150	130	130
zulässige brennstoffmenge permitted fuel quantity	kg	1,5 - 2,5	1,5 - 2,5	1,5 - 2,5	1,5 - 2,5	1,5 - 2,5	2 - 3
feuerraumtiefe combustion chamber dept	cm	40	40	38	60	40	45
empfohlene scheinlänge recommended log length	cm	25/33	25/33	25/33	33/50	25/33	25/33
gewicht gusseisen cast iron weight	kg	130	150	135	240	200	310
gesamtwicht sterling Silber/gold sterling silver/gold total weight	kg	---	---	---	---	260/380	---

## luftmengen air quantities

verbrennungsluftbedarf combustion air consumption	m <sup>3</sup> /h	15	15	15	18	15	18
--	-------------------	----	----	----	----	----	----

## mindestabstände required minimum clearances

zur seitenwand to the side wall	cm	80	80	80	60	80	25
zur rückwand (ohne strahlungsblech) to the rear wall (without insulation panel)	cm	40	40	40	---	40	20
zur rückwand (mit ofenstrahlungsblech) to the rear wall (with insulation panel stove)	cm	30	30	30	30	30	---
zur rückwand (mit ofen- & wandstrahlungsblech) to the rear wall (with insulation panel stove & wall)	cm	10	10	10	10	10	---

## zulassungen approvals

		EN 13240	EN 13240	EN 13240	EN 13240	EN 13240	EN 13240
--	--	----------	----------	----------	----------	----------	----------

<sup>1)</sup> die ermittlung der daten erfolgte im EN 13240-versuch mit kaminofen mit waagrechttem rauchrohranschluß, rohrlänge 35 cm

<sup>1)</sup> the data was determined in an EN 13240 test with a chimney stove with a horizontal smoke tube connection, tube length 35 cm

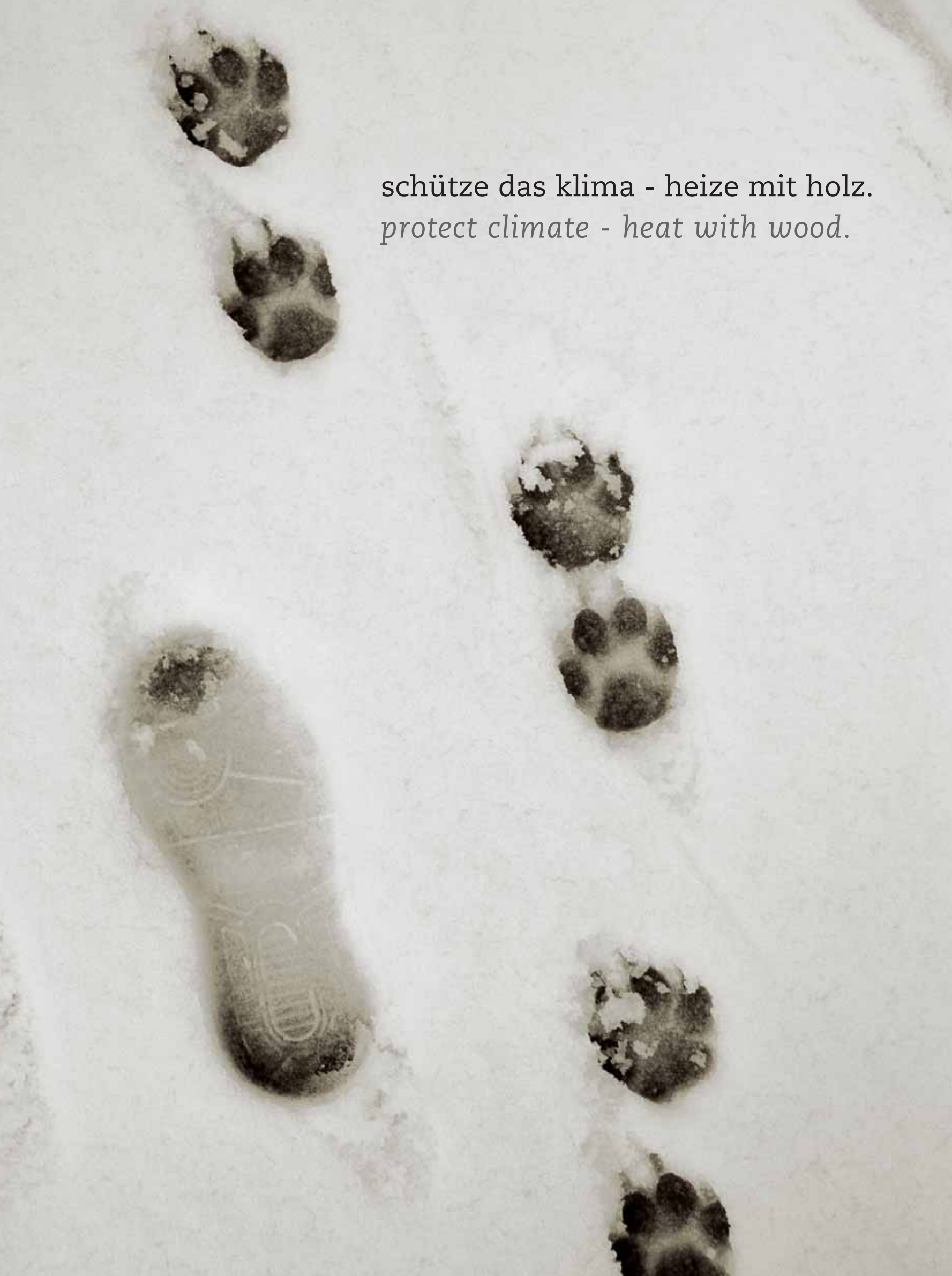
A path of paw prints and a boot print is visible in the snow. The paw prints are dark and arranged in a line, with a larger boot print at the bottom left. The text is centered in the upper right area of the image.

schütze das klima - heize mit holz.  
*protect climate - heat with wood.*

made in germany.

# IRON DOG<sup>®</sup>

## EISERNER HUND<sup>®</sup>

IRON DOG ist ein Produkt der Ulrich Brunner GmbH, Eggenfelden  
*IRON DOG is a product of Ulrich Brunner GmbH, Eggenfelden, Germany*

IRON DOG ist eine geschützte Marke.  
*IRON DOG is a registered trademark.*

Ulrich Brunner GmbH  
Zellhuber Ring 17 - 18  
D-84307 Eggenfelden  
Germany  
Telefon: +49 8721 771-0  
Telefax: +49 8721 771-100  
info@iron-dog.com www.iron-dog.com

IRON DOG wird ausschließlich von IRON DOG-Partnern angeboten und verkauft.  
Technische und Sortiments-Änderungen sowie Irrtum vorbehalten.

*IRON DOG is exclusively distributed by IRON DOG-Partners.  
All products presented are subject to changes in technology, design and availability.*

